



---

# Service Manual

## CT225, CT230 & CT235 Compact Tractor

---

S/N ABFJ11001 & Above  
S/N ABFP11001 & Above  
S/N A9JY11001 & Above

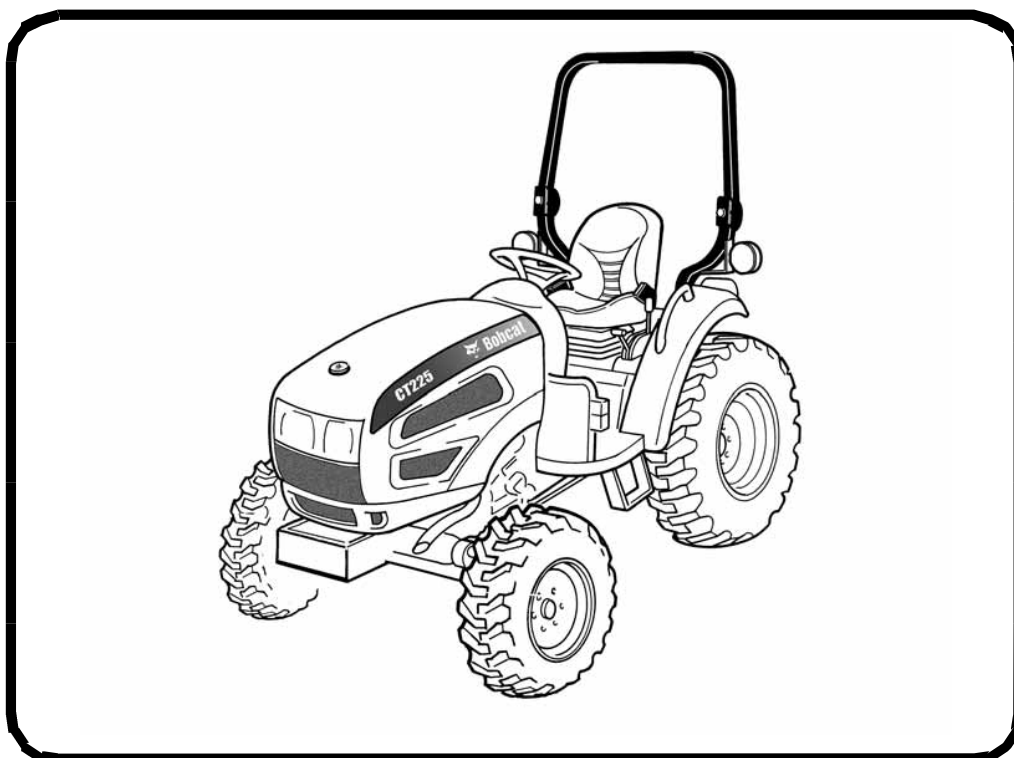



# MAINTENANCE SAFETY



## WARNING

Instructions are necessary before operating or servicing machine. Read and understand the Operation & Maintenance Manual, Operator's Handbook and signs (decals) on machine. Follow warnings and instructions in the manuals when making repairs, adjustments or servicing. Check for correct function after adjustments, repairs or service. Untrained operators and failure to follow instructions can cause injury or death.

W-2003-0807



**Safety Alert Symbol:** This symbol with a warning statement, means: "Warning, be alert! Your safety is involved!" Carefully read the message that follows.

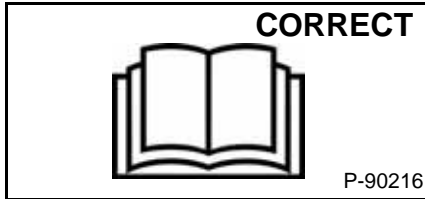

⚠ Never service the machine without instructions.

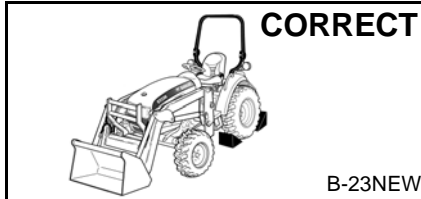

⚠ Before exiting machine, engage parking brake. Chock wheels before servicing

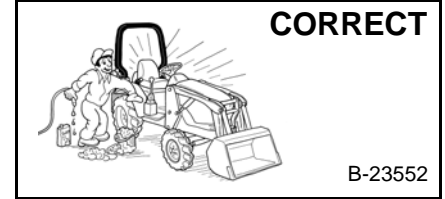

⚠ Cleaning and maintenance are required daily.



⚠ Have good ventilation when welding or grinding painted parts.  
 ⚠ Wear dust mask when grinding painted parts. Toxic dust and gas can be produced.  
 ⚠ Avoid exhaust fume leaks which can kill without warning. Exhaust system must be tightly sealed.

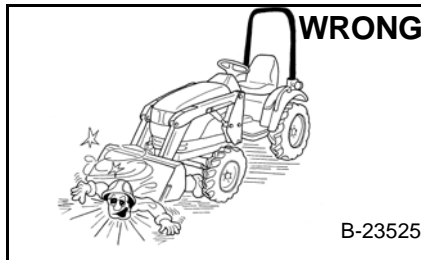

⚠ Disconnecting or loosening any hydraulic tubeline, hose, fitting, component or a part failure can cause loader arms to drop.  
 ⚠ Lower loader arms, attachments, and implements (if equipped) before servicing.  
 ⚠ DO NOT service the compact tractor or implement with the PTO system engaged.



⚠ Never start the machine if not properly seated in the operator's seat.  
 ⚠ Never work on the machine with loader arms raised.  
 ⚠ Never modify equipment or add attachments not approved by Bobcat Company.

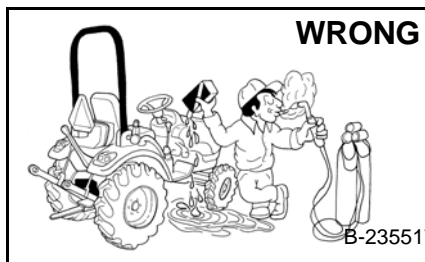

⚠ Stop, cool and clean engine of flammable materials before checking fluids.  
 ⚠ Never service or adjust machine with the engine running unless instructed to do so in the manual.  
 ⚠ Avoid contact with leaking hydraulic fluid or diesel fuel under pressure. It can penetrate the skin or eyes.  
 ⚠ Never fill fuel tank with engine running, while smoking or when near open flame.

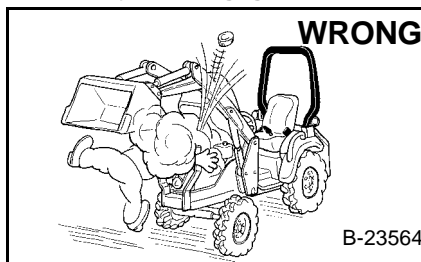

⚠ Keep body, jewelry and clothing away from moving parts, electrical contact, hot parts and exhaust.  
 ⚠ Wear eye protection to guard from battery acid, compressed springs, fluids under pressure and flying debris when engines are running or tools are used. Use eye protection approved for type of welding.  
 ⚠ Keep engine cover and side access panels closed except for service.

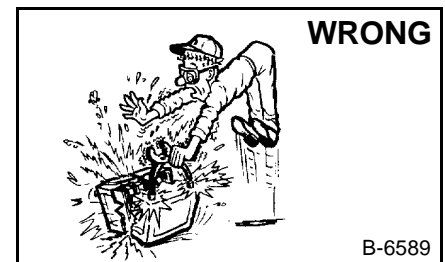

⚠ Lead-acid batteries produce flammable and explosive gases.  
 ⚠ Keep arcs, sparks, flames and lighted tobacco away from batteries.  
 ⚠ Batteries contain acid which burns eyes or skin on contact. Wear protective clothing. If acid contacts body, flush well with water. For eye contact, flush well and get immediate medical attention.

Maintenance procedures which are given in the Operation & Maintenance Manual can be performed by the owner/operator without any specific technical training. Maintenance procedures which are **not** in the Operation & Maintenance Manual must be performed **ONLY BY QUALIFIED BOBCAT SERVICE PERSONNEL**. Always use genuine Bobcat replacement parts.



**Bobcat®**

## ALPHABETICAL INDEX

AIR CLEANER .....	70-01	HYDRAULIC FILTER .....	20-01
AIR CLEANER SERVICE .....	10-01	HYDRAULIC FLUID .....	SPEC-01
ALTERNATOR .....	60-01	HYDRAULIC PUMP .....	20-01
ALTERNATOR BELT .....	10-01	HYDRAULIC SYSTEM INFORMATION .....	20-01
AUXILIARY CONTROL VALVE .....	20-01	HYDRAULIC /HYDROSTATIC/ TRANSMISSION SYSTEM .....	10-01
AXLE AND DIFFERENTIAL .....	40-01	HYDROSTATIC PUMP .....	30-01
AXLE CASE .....	40-01	HYDROSTATIC PUMP TESTING .....	30-01
AXLE TOE IN .....	10-01	HYDROSTATIC SYSTEM INFORMATION .....	30-01
BATTERY.....	60-01	HYDROSTATIC TRANSMISSION CASE .....	50-01
BRAKE CASE .....	40-01	HOOD LIGHTS.....	60-01
BRAKE PEDAL ASSEMBLY .....	40-01	HORN .....	60-01
BRAKE SYSTEM .....	10-01	INSTRUMENT PANEL.....	60-01
CAMSHAFT AND TIMING GEARS.....	70-01	LUBRICATING THE COMPACT TRACTOR .....	10-01
CLUTCH ASSEMBLY .....	70-01	LUBRICATION SYSTEM .....	70-01
CLUTCH HOUSING.....	70-01	MAIN RELIEF VALVE .....	20-01
CLUTCH SYSTEM .....	10-01	MID PTO CONTROL .....	50-01
COMPACT TRACTOR STORAGE AND RETURN TO SERVICE .....	10-01	MLS VALVE .....	20-01
CONSOLE COVER .....	50-01	OIL COOLER.....	20-01
CONVERSIONS .....	SPEC-01	OPERATOR SEAT.....	50-01
CRANKSHAFT AND PISTONS .....	70-01	PARKING BRAKE SYSTEM.....	10-01
CRUISE CONTROL .....	60-01	PIVOT PINS .....	10-01
CYLINDER HEAD.....	70-01	PTO SAFETY SHIELD .....	50-01
DRIVE SHAFT .....	50-01	PTO SWITCHES .....	60-01
DRAW BAR.....	50-01	REAR LIGHTS.....	60-01
DRAW BAR ASSEMBLY .....	50-01	REAR PTO CONTROL.....	50-01
ELECTRICAL SYSTEM INFORMATION .....	60-01	RIGHT JOYSTICK (IF EQUIPPED).....	20-01
ENGINE COOLING SYSTEM.....	10-01, 70-01	RIGHT JOYSTICK VALVE (IF EQUIPPED).....	20-01
ENGINE COVER .....	10-01, 50-01	ROPS .....	50-01
ENGINE INFORMATION .....	70-01	ROCK SHAFT .....	20-01
ENGINE LUBRICATION SYSTEM.....	10-01	SAFETY INTERLOCK SYSTEM - NEUTRAL START .....	10-01
ENGINE SIDE COVER .....	50-01	SAFETY INTERLOCK SYSTEM - OPERATING.....	10-01
ENGINE SPEED CONTROL .....	70-01	SEAT BELT.....	10-01
FAN.....	70-01	SEAT SENSOR .....	60-01
FENDER .....	50-01	SEPERATING THE TRACTOR .....	40-01
FENDER ASSEMBLY .....	50-01	SERVICE BRAKE .....	40-01
FIREWALL .....	50-01	SERVICE SCHEDULE .....	10-01
FLOOR PLATE.....	50-01	SPARK ARRESTOR MUFFLER.....	10-01, 70-01
FLOORMAT .....	50-01	SPECIFICATIONS .....	SPEC-01
FLYWHEEL AND HOUSING.....	70-01	SPLASH BOARD.....	50-01
FUEL, COOLANT AND LUBRICANTS (ALL MODELS).....	SPEC-01	STARTER .....	60-01
FUEL LEVEL SENDER.....	60-01		
FUEL SYSTEM .....	10-01, 70-01		
FUEL TANK.....	50-01		
FRONT AXLE .....	10-01, 40-01		

Continued On Next Page

## ALPHABETICAL INDEX (CONT'D)

STEERING AXLE ADJUSTMENT .....	40-01
STEERING CYLINDER .....	20-01
STEERING VALVE .....	20-01
SUPPORTING THE COMPACT TRACTOR	
ON JACKSTANDS .....	10-01
THREE POINT CYLINDER .....	20-01
THREE POINT CYLINDER CONTROL .....	20-01
THREE POINT HITCH HOUSING .....	20-01
THREE POINT HITCH LOWER LINKS .....	50-01
TIRE MAINTENANCE .....	10-01
TORQUE SPECIFICATIONS FOR BOLTS.....	SPEC-01
TOWING THE COMPACT TRACTOR .....	10-01
TRANSMISSION .....	40-01
TRANSPORTING THE COMPACT TRACTOR ON A	
TRAILER.....	10-01
TRAVEL CONTROL PEDAL.....	10-01
TRAVEL PEDAL .....	30-01
TROUBLESHOOTING.....	40-01

## CONTENTS

FOREWORD.....	II
SAFETY INSTRUCTIONS .....	V
FIRE PREVENTION .....	VIII
SERIAL NUMBER LOCATIONS .....	X
DELIVERY REPORT.....	XI
COMPACT TRACTOR IDENTIFICATION.....	XII
COMPACT TRACTOR IDENTIFICATION (WITH OPTIONAL LOADER AND REAR BALLAST) .....	XIII
COMPACT TRACTOR IDENTIFICATION (WITH OPTIONAL THREE- POINT IMPLEMENT AND FRONT BALLAST) .....	XIV
SAFETY AND MAINTENANCE.....	10-01
HYDRAULIC SYSTEM .....	20-01
HYDROSTATIC SYSTEM.....	30-01
DRIVE SYSTEM .....	40-01
MAINFRAME.....	50-01
ELECTRICAL SYSTEM .....	60-01
ENGINE SERVICE .....	70-01
SPECIFICATIONS.....	SPEC-01

**SAFETY AND  
MAINTENANCE**

**HYDRAULIC  
SYSTEM**

**HYDROSTATIC  
SYSTEM**

**DRIVE SYSTEM**

**MAINFRAME**

**ELECTRICAL  
SYSTEM**

**ENGINE SERVICE**

**SPECIFICATIONS**

# FOREWORD

This manual is for the Bobcat compact tractor mechanic. It provides necessary servicing and adjustment procedures for the Bobcat compact tractor and its component parts and systems. Refer to the Operation & Maintenance Manual for operating instructions, starting procedure, daily checks, etc.

A general inspection of the following items must be made after the compact tractor has had service or repair:

1. Check that the ROPS is in good condition and is not modified.



2. Check that ROPS mounting hardware is tightened and is Bobcat approved.

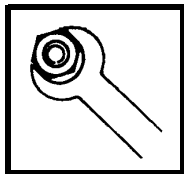

3. The seat belt must be correctly installed, functional and in good condition.

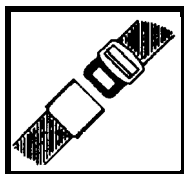

4. Machine signs (decals) must be legible and in the correct location.



5. Travel control pedal(s) and loader joystick control lever must return to neutral.



6. Check for correct function of the work lights.

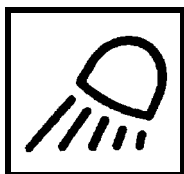

7. The parking brake must function correctly.

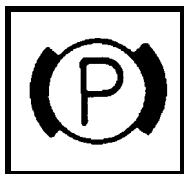

8. Enclosure door latches must open and close freely.

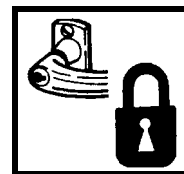

9. Attachment locking pins must function correctly and be in good condition. Bob-Tach wedges and linkages (if equipped) must function correctly and be in good condition.

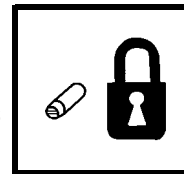

10. Safety treads must be in good condition.

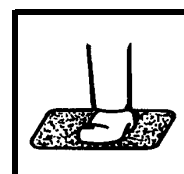

11. Check for correct function of indicator lamps.

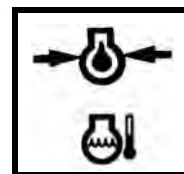

12. Check hydraulic fluid level, engine oil level and fuel supply.

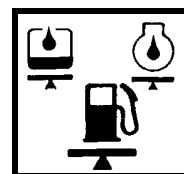

13. Inspect for fuel, oil or hydraulic fluid leaks.

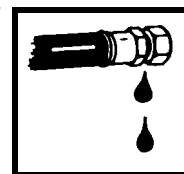

14. Lubricate the compact tractor.

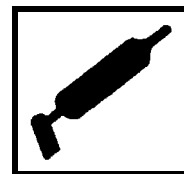



15. Check the condition of the battery and cables.

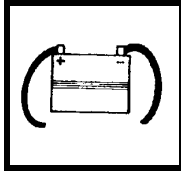

20. Check for any field modification not completed.



16. Inspect the air cleaner for damage or leaks. Check the condition of the element.

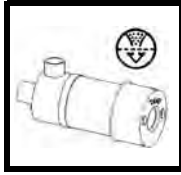

21. Operate the machine and check all functions.



17. Check the electrical charging system.

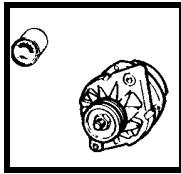

22. Check Safety Interlock System (Neutral Start and Operating) for correct function before the machine is returned to the customer.



18. Check tires for wear and pressure. Use only approved tires.

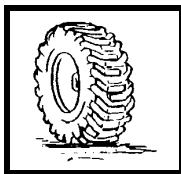

23. Check function or condition of all equipped options and accessories (examples: back-up alarm, front-end loader, etc.).



19. Inspect for loose or broken parts or connections.

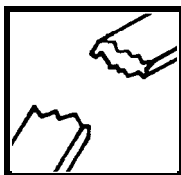

24. Recommend to the owner that all necessary corrections be made before the machine is returned to service.

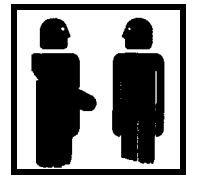

**CALIFORNIA  
PROPOSITION 65 WARNING**  
Diesel engine exhaust and some of its constituents are known to the state of California to cause cancer, birth defects and other reproductive harm.



**Bobcat®**

## SAFETY INSTRUCTIONS



### Safety Alert Symbol

This symbol with a warning statement means:  
“Warning, be alert! Your safety is involved!”  
Carefully read the message that follows.



## WARNING

Instructions are necessary before operating or servicing machine. Read and understand the Operation & Maintenance Manual, Operator's Handbook and signs (decals) on machine. Follow warnings and instructions in the manuals when making repairs, adjustments or servicing. Check for correct function after adjustments, repairs or service. Untrained operators and failure to follow instructions can cause injury or death.

W-2003-0903

## IMPORTANT

This notice identifies procedures which must be followed to avoid damage to the machine.

I-2019-0284



## DANGER

The signal word DANGER on the machine and in the manuals indicates a hazardous situation which, if not avoided, will result in death or serious injury.

D-1002-1107



## WARNING

The signal word WARNING on the machine and in the manuals indicates a potentially hazardous situation which, if not avoided, could result in death or serious injury.

W-2044-1107

The following publications provide information on the safe use and maintenance of the Bobcat machine and attachments:

- The Delivery Report is used to assure that complete instructions have been given to the new owner and that the machine is in safe operating condition.
- The Operation & Maintenance Manual delivered with the machine or attachment / implement contains operating information as well as routine maintenance and service procedures. It is a part of the machine and can be stored in a container provided on the machine. Replacement Operation & Maintenance Manuals can be ordered from your Bobcat dealer.
- Machine signs (decals) instruct on the safe operation and care of your Bobcat machine or attachment / implement. The signs and their locations are shown in the Operation & Maintenance Manual. Replacement signs are available from your Bobcat dealer.
- An Operator's Handbook fastened below the instrument panel. It's brief instructions are convenient to the operator. The handbook is available from your dealer in an English edition or one of many other languages. See your Bobcat dealer for more information on translated versions.
- The AEM Safety Manual delivered with the machine gives general safety information.
- The Service Manual and Parts Manual are available from your dealer for use by mechanics to do shop-type service and repair work.

## SAFETY INSTRUCTIONS (CONT'D)

### Use Safety Rules

- Read and follow instructions in the machine and the attachment's / implement's Operation & Maintenance Manual before operating.
- Check for underground lines before operating attachment / implement (if applicable).
- In addition to the design and configuration of equipment, hazard control and accident prevention are dependent upon the awareness, concern, prudence and proper training of personnel involved in the operation, transport, maintenance and storage of equipment.
- Check that the attachment mounting pins and hardware are installed correctly and securely fastened (if equipped).
- Check that the loader is securely installed to the compact tractor using the correct pins and hardware.
- Check that the Bob-Tach levers are in the locked position and the wedges are fully engaged into the mounting holes of the attachment (if applicable).
- Check that the implement is securely fastened to the machine.
- Depress brake pedals (or make sure parking brake is engaged) and make sure all the machine controls are in the NEUTRAL position before starting the machine.
- Always start the machine from the operator's seat.
- Operate the attachment / implement according to the Operation & Maintenance Manual.
- When learning to operate the attachment / implement, do it at a slow rate in an area clear of bystanders.
- DO NOT permit personnel to be in the work area when operating the machine and attachment / implement.
- The attachment / implement must be used ONLY on approved machines. See your Bobcat dealer for updated list of approved attachments / implements for each machine model.
- DO NOT modify equipment or add attachments / implements that exceed manufacturer's specifications.
- DO NOT make any adjustments or repairs on the machine or attachment / implement while the engine is running.
- Keep shields and guards in place. Replace if damaged.



## Call Before You Dig Dial 811 (USA Only) 1-888-258-0808 (USA & Canada)

When you call, you will be directed to a location in your state / province, or city for information about buried lines (telephone, cable TV, water, sewer, gas, etc.).



Cutting or drilling concrete containing sand or rock containing quartz may result in exposure to silica dust. Do not exceed Permissible Exposure Limits (PEL) to silica dust as determined by OSHA or other job site Rules and Regulations. Use a respirator, water spray or other means to control dust. Silica dust can cause lung disease and is known to the state of California to cause cancer.

SI CT-1008 SM

## **SAFETY INSTRUCTIONS (CONT'D)**

### **Safety Rules For Power Take-Off (PTO) Driven Implements**

- Keep PTO shields and all guards in place. Replace damaged or missing shields and guards before operating.
- Follow warnings and instructions on machine signs (decals). Replace damaged or missing decals.
- Do not wear loose or bulky clothing around the PTO or other moving parts.
- Keep bystanders away from PTO driven equipment, and never allow children near machines.
- Read and understand the manuals for the PTO driven equipment and be aware of safe operating procedures and hazards that may not be readily apparent.
- Always walk around equipment to avoid coming near a turning PTO driveline. Stepping over, leaning across or crawling under a turning PTO driveline can cause entanglement.
- Position the machine and implement hitch correctly to prevent driveline stress and separation.
- Use caution when turning. Turning too sharp can cause driveline damage.
- Use caution when raising PTO driven implement. Excessive driveline angle can cause driveline damage. Use stops if needed.

### **Compact Tractor Requirements and Capabilities**

- Fasten seat belt securely when Roll-Over Protective Structure (ROPS) is up and locked. DO NOT wear seat belt if ROPS is down.
- Compact tractor must be equipped with sway bars or chains.
- Stop the compact tractor and engage the parking brakes. Install blocks in front of and behind the rear tires of the compact tractor. Install blocks underneath and support the implement securely before working under raised implements.
- Keep bystanders clear of moving parts and the work area. Keep children away.
- Use increased caution on slopes and near banks and ditches to prevent overturn.

- Make certain that the Slow Moving Vehicle (SMV) emblem is installed so that it is visible and legible. When transporting the equipment, use the compact tractor flashing warning lights and follow all local regulations.
- Operate this equipment with a compact tractor equipped with an approved Roll-Over Protective Structure (ROPS). Always wear seat belt when the ROPS is up. Serious injury or death could result from falling off the compact tractor.
- Before leaving the compact tractor operator's seat:
  1. Park on flat level ground.
  2. Fully lower the loader arms and put the attachment flat on the ground (if equipped).
  3. Fully lower the three-point hitch or mid-mount implements (if equipped).
  4. Lock brake pedals together and engage the parking brake.
  5. Place all controls in neutral.
  6. Stop engine, unfasten seat belt and remove the key.
- Never allow riders on the compact tractor or implement. Falling off can result in serious injury or death.
- Start the compact tractor only when properly seated in the operator's seat. Starting a compact tractor in gear can result in serious injury or death.
- Operate the compact tractor and attachments / implements from the operator's position only.
- Add the correct front ballast for rear three-point hitch implements and pull type implements. Add the correct rear ballast when using the loader and attachments. Front and rear ballast can be purchased from your compact tractor dealer.
- Do not handle large objects (such as round bales or posts) unless the loader is equipped with the proper attachment and the load is secured.
- The parking brake must be engaged before leaving the compact tractor operator's seat. Rollaway can occur because the transmission may not prevent machine movement. Lock the brake pedals together before activating the parking brake.

SI CT-1008 SM

## FIRE PREVENTION



### Maintenance

The machine and some attachments / implements have components that are at high temperatures under normal operating conditions. The primary source of high temperatures is the engine and exhaust system. The electrical system, if damaged or incorrectly maintained, can be a source of arcs or sparks.

Flammable debris (leaves, straw, etc.) must be removed regularly. If flammable debris is allowed to accumulate, it can cause a fire hazard. Clean often to avoid this accumulation. Flammable debris in the engine compartment is a potential fire hazard.

The operator's area, engine compartment and engine cooling system must be inspected every day and cleaned if necessary to prevent fire hazards and overheating.

All fuels, most lubricants and some coolants mixtures are flammable. Flammable fluids that are leaking or spilled onto hot surfaces or onto electrical components can cause a fire.

### Operation

Do not use the machine where exhaust, arcs, sparks or hot components can contact flammable material, explosive dust or gases.

### Electrical



Check all electrical wiring and connections for damage. Keep the battery terminals clean and tight. Repair or replace any damaged part or wires that are loose or frayed.

Battery gas can explode and cause serious injury. Use the procedure in the Operation & Maintenance Manual for connecting the battery and for jump starting. Do not jump start or charge a frozen or damaged battery. Keep any open flames or sparks away from batteries. Do not smoke in battery charging area.

## Hydraulic System

Check hydraulic tubes, hoses and fittings for damage and leakage. Never use open flame or bare skin to check for leaks. Hydraulic tubes and hoses must be properly routed and have adequate support and secure clamps. Tighten or replace any parts that show leakage.

Always clean fluid spills. Do not use gasoline or diesel fuel for cleaning parts. Use commercial nonflammable solvents.

### Fueling



Stop the engine and let it cool before adding fuel. No smoking! Do not refuel a machine near open flames or sparks. Fill the fuel tank outdoors.

### Starting

Do not use ether or starting fluids on any engine that has glow plugs. These starting aids can cause explosion and injure you or bystanders.

Use the procedure in the Operation & Maintenance Manual for connecting the battery and for jump starting.

### Spark Arrestor Exhaust System

The spark arrestor exhaust system is designed to control the emission of hot particles from the engine and exhaust system, but the muffler and the exhaust gases are still hot.

Check the spark arrestor exhaust system regularly to make sure it is maintained and working properly. Use the procedure in the Operation & Maintenance Manual for cleaning the spark arrestor muffler (if equipped).

SI CT-1008 SM

## **FIRE PREVENTION (CONT'D)**

### **Welding And Grinding**

Always clean the machine and attachment / implement, disconnect the battery, and disconnect the wiring from the Bobcat controllers before welding. Cover rubber hoses, battery and all other flammable parts. Keep a fire extinguisher near the machine when welding.

Have good ventilation when grinding or welding painted parts. Wear dust mask when grinding painted parts. Toxic dust or gas can be produced.

Dust generated from repairing nonmetallic parts such as hoods, fenders or covers can be flammable or explosive. Repair such components in a well ventilated area away from open flames or sparks.

### **Fire Extinguishers**

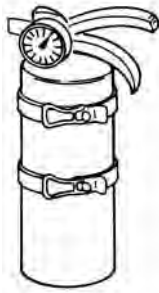

Know where fire extinguishers and first aid kits are located and how to use them. Inspect the fire extinguisher and service the fire extinguisher regularly. Obey the recommendations on the instructions plate.

## SERIAL NUMBER LOCATIONS

Always use the serial number of the compact tractor when requesting service information or when ordering parts. Early or later models (identification made by serial number) may use different parts, or it may be necessary to use a different procedure in doing a specific service operation.

**Figure 1**

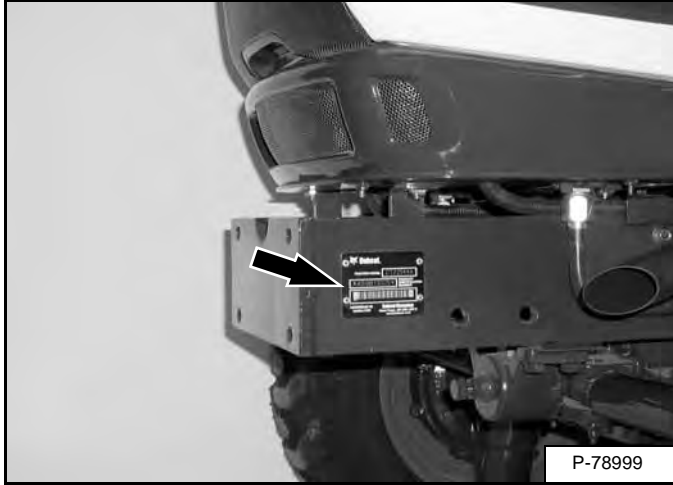

### Compact Tractor Serial Number

The compact tractor serial number plate is located on the left front corner of the frame [Figure 1].

Explanation of machine Serial Number:

XXXX XXXXXX

Module 2. - Production Sequence (Series)

Module 1. - Model / Engine Combination

1. The four digit Model/Engine Combination Module number identifies the model number and engine combination.

2. The five digit Production Sequence Number identifies the order which the compact tractor is produced.

## Engine Serial Number

**Figure 2**

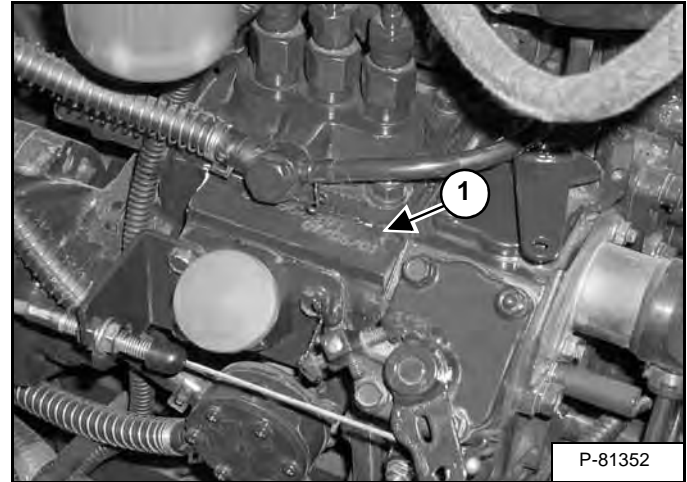

The engine serial number is located on the top of the injection pump (Item 1) [Figure 2].

## Loader Serial Number (Optional)

**Figure 3**

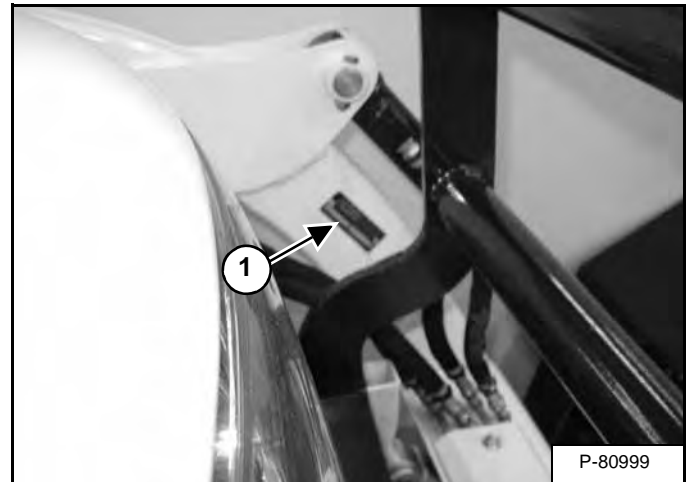

The loader serial number is located on the right loader arm (Item 1) [Figure 3].



## DELIVERY REPORT

Figure 4

The diagram shows a form titled "DELIVERY REPORT". The form is divided into several sections. At the top right, there is a box labeled "DELIVERY REPORT" containing a grid of lines for text entry. Below this, on the left side, is a box labeled "WARNING" with a dark background and white text, followed by several lines of text. To the right of the "WARNING" box is another large section with a grid of lines for text entry. At the bottom right of the form, there is a small box containing the text "B-16315".

The delivery report must be filled out by the dealer and signed by the owner or operator when the compact tractor is delivered. An explanation of the form must be given to the owner. Make sure it is filled out completely **[Figure 4]**.

**COMPACT TRACTOR IDENTIFICATION**

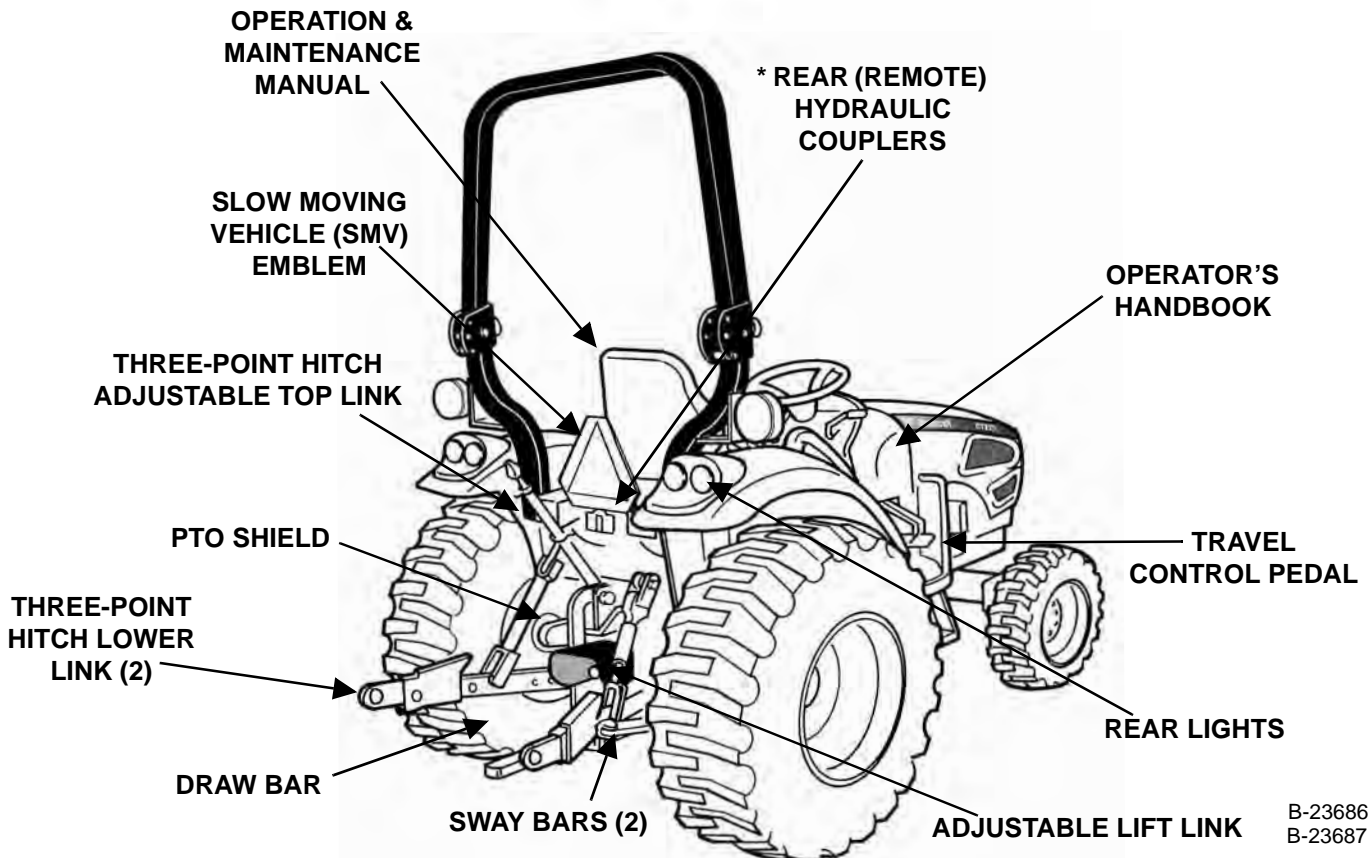
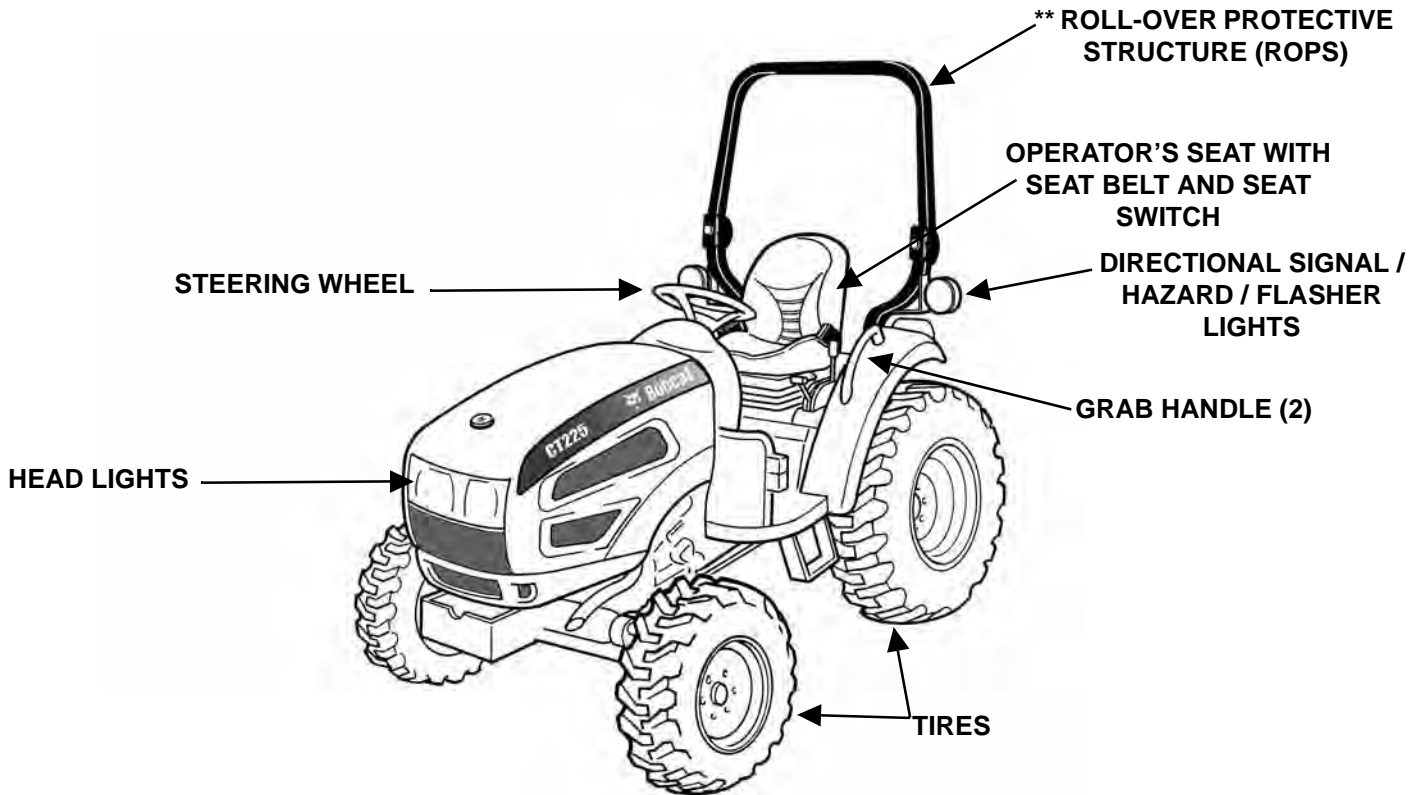

B-23686  
B-23687

\*\*\* ATTACHMENTS AND IMPLEMENTS - Attachments and implements are available for the compact tractor.

\*\* ROPS - Roll Over Protective Structure per ASABE S478 and OSHA 29 CFR PART 1928 Subpart C

\* OPTIONAL OR FIELD ACCESSORIES (Not standard equipment)

**Dear**

**Thanks very much for your visiting and  
patience.**

**Want to get more information,**

**Please click here, Go back to the page.**

**After your payment, you will have instant access to  
your download.**

**The Download Link will also be sent to your e-mail.**

**You will get the complete manual**

**Have any questions**

**please write to me**

**[admin@servicemanualperfect.com](mailto:admin@servicemanualperfect.com)**