

Concrete Mixer



Bobcat®

Service Manual

S/N 678500101 & Above

S/N A01600101 & Above

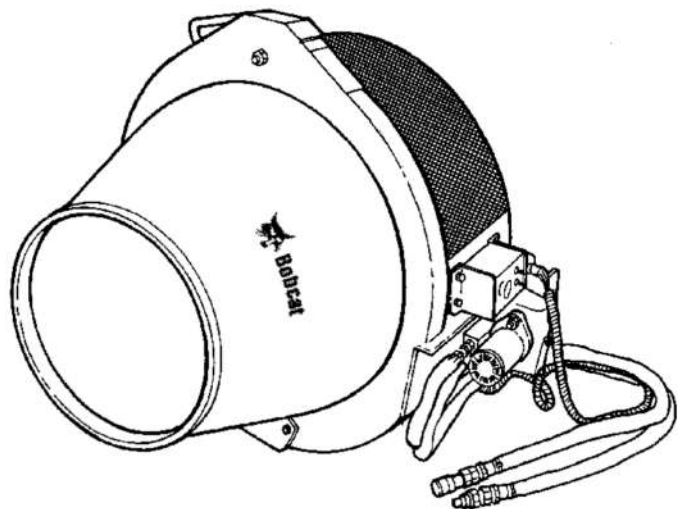

MAINTENANCE SAFETY



WARNING

Instructions are necessary before operating or servicing machine. Read and understand the Operation & Maintenance Manual, Operator's Handbook and signs (decals) on machine. Follow warnings and instructions in the manuals when making repairs, adjustments or servicing. Check for correct function after adjustments, repairs or service. Untrained operators and failure to follow instructions can cause injury or death.







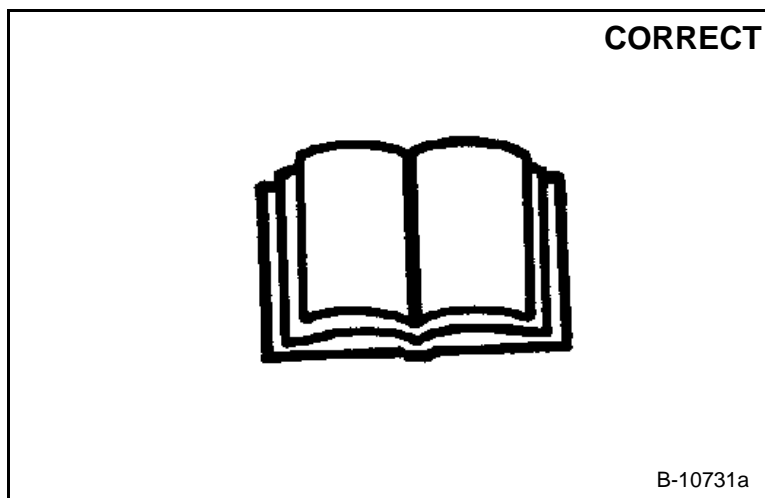

W-2003-0903



Safety Alert Symbol: This symbol with a warning statement, means: "Warning, be alert! Your safety is involved!" Carefully read the message that follows.



B-10731a

-  Never service attachments without instructions. See Operation & Maintenance Manual and Attachment Service Manual.
-  Cleaning and maintenance are required daily.
-  Never service or adjust attachment with the engine running unless instructed to do so in manual.
-  Always lower the attachment to the ground before lubricating or servicing.
-  Avoid contact with leaking hydraulic fluid or diesel fuel under pressure. It can penetrate skin or eyes.
-  Stop, cool and clean engine of flammable materials before checking fluids.
-  Keep body, loose objects and clothing away from moving parts, electrical contacts, hot parts and exhaust.
-  Safety glasses are needed for eye protection from electrical arcs, battery acid, compressed springs, fluids under pressure and flying debris or when tools are used. Use eye protection approved for type of welding.



Bobcat®

ALPHABETICAL INDEX

ATTACHMENT DELIVERY REPORT	III
BEARING	30-10-1
CONCRETE MIXER ELECTRICAL SCHEMATIC	SPEC-40-1
DRUM ROLLER	30-20-1
GLOSSARY OF HYDRAULIC SYMBOLS FOR ATTACHMENTS	SPEC-20-1
GREASE SEAL	30-30-1
HYDRAULIC CONTROL VALVE	20-20-1
HYDRAULIC MOTOR	20-10-1
HYDRAULIC SCHEMATIC	SPEC-30-1
IDENTIFICATION	IV
INNER DRUM	30-40-1
INSPECTION	10-30-1
LOADER REMOTE ATTACHMENT CONTROL ELECTRICAL SCHEMATIC	SPEC-50-1
LUBRICATION	10-20-1
MIXING DRUM DRIVE CHAIN	30-50-1
MIXING DRUM DRIVE SPROCKET	30-60-1
MIXING PADDLES	30-70-1
REMOTE ATTACHMENT CONTROL	40-10-1
SHAFT MOUNT	30-80-1
SPECIFICATIONS	SPEC-10-1
TROUBLESHOOTING	10-10-1



Bobcat®

CONTENTS

ATTACHMENT DELIVERY REPORT	III
IDENTIFICATION AND MACHINE SIGNS (DECALS)	IV
SERIAL NUMBER LOCATION	III
SAFETY AND MAINTENANCE.....	10-01
HYDRAULIC SYSTEM	20-01
MAIN FRAME	30-01
ELECTRICAL SYSTEM	40-01
SPECIFICATIONS AND SCHEMATICS	SPEC-01

**SAFETY AND
MAINTENANCE**

**HYDRAULIC
SYSTEM**

**MAIN
FRAME**

**ELECTRICAL
SYSTEM**

**SPECIFICATIONS
AND
SCHEMATICS**

**CALIFORNIA
PROPOSITION 65 WARNING**

Diesel engine exhaust and some of its constituents are known to the State of California to cause cancer, birth defects and other reproductive harm.



Bobcat®

SERIAL NUMBER LOCATION

Figure 1

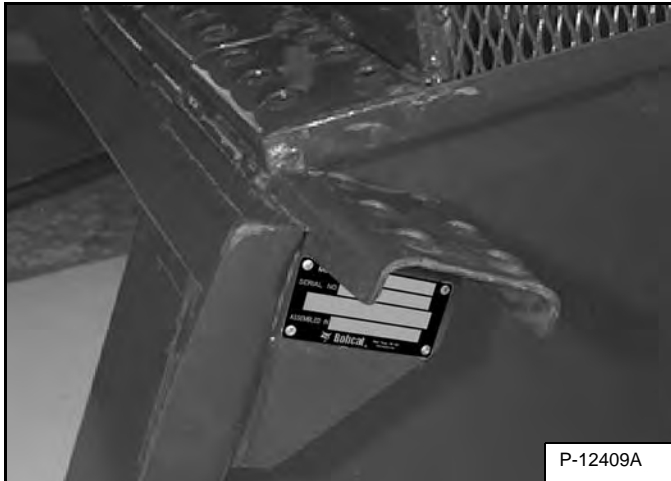

Always use the serial number of the Concrete Mixer when requesting service information or when ordering parts. Early or later models (identification made by serial number) may use different parts, or it may be necessary to use a different procedure in doing a specific service operation [Figure 1].

ATTACHMENT DELIVERY REPORT

Figure 2

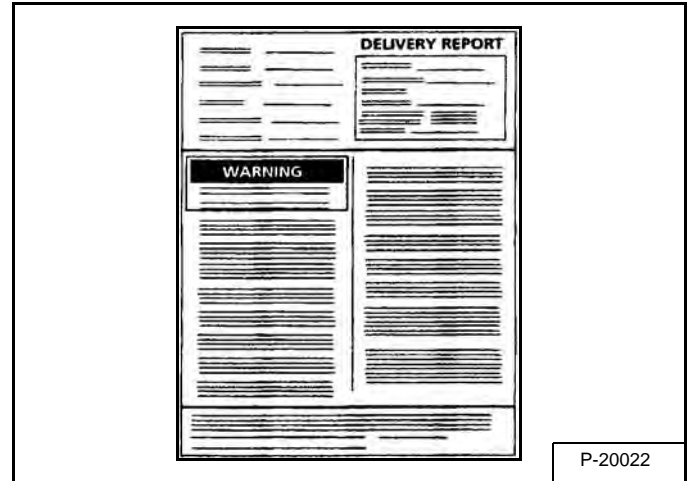

The Attachment Delivery Report must be filled out by the dealer and signed by the owner or operator when the Concrete Mixer is delivered. An explanation of the form must be given to the owner. Make sure it is filled out completely [Figure 2].

IDENTIFICATION AND MACHINE SIGNS (DECALS)

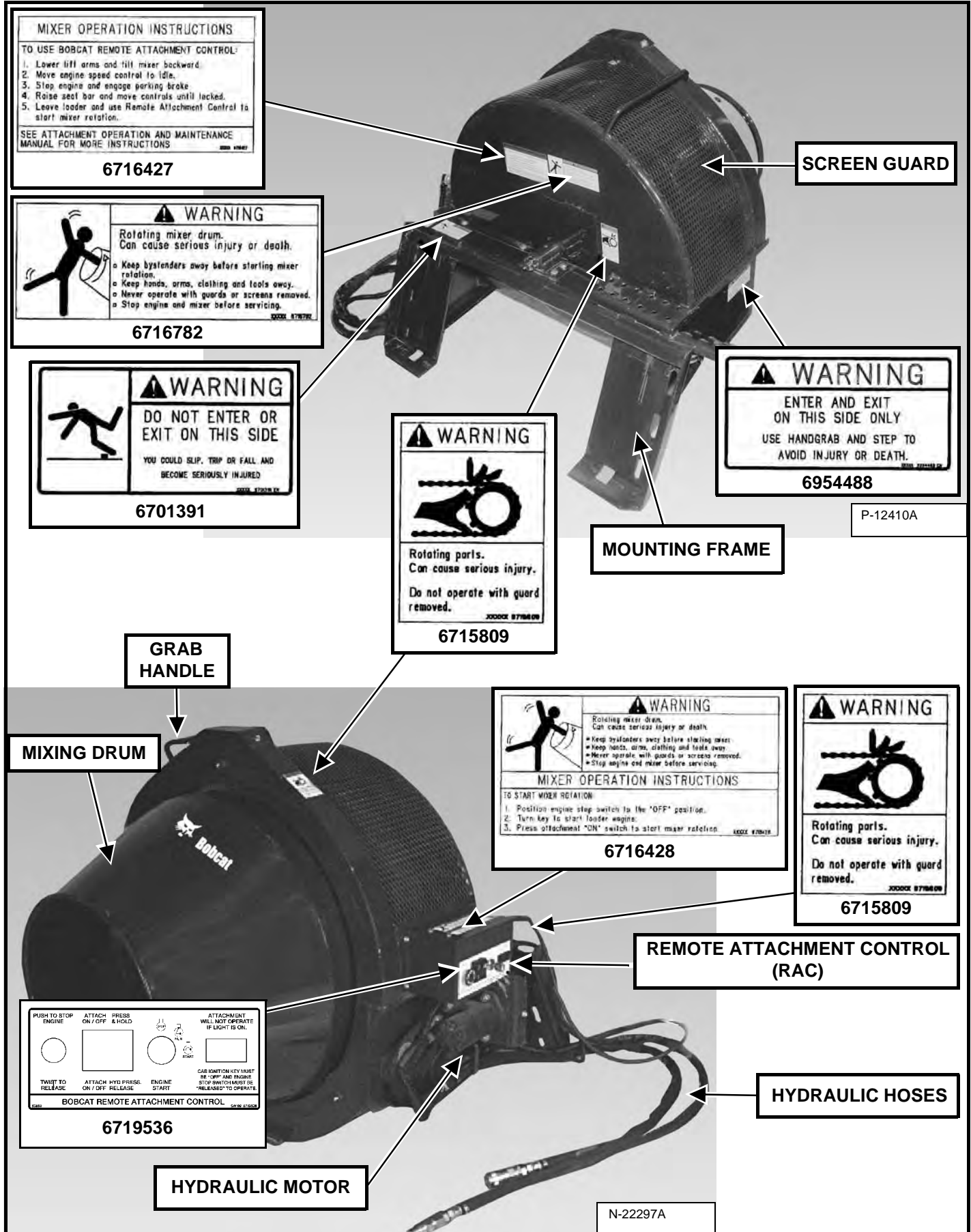

SAFETY AND MAINTENANCE

SAFETY AND MAINTENANCE

LUBRICATION	10-20-1
INSPECTION	10-30-1
Concrete Mixer Mount Inspection	10-30-3
Hand Lever Bob-Tach Inspection.....	10-30-1
Power Bob-Tach Inspection.....	10-30-2
TROUBLESHOOTING	10-10-1



Bobcat®

TROUBLESHOOTING

PROBLEM	CAUSE	CORRECTION
Concrete Mixer does not seat properly on the Bob-Tach.	Bob-Tach pins are not fully retracted prior to installation.	Retract Bob-Tach pins before installing.
	Mud, dirt or stones are lodged between the Bob-Tach and the Concrete Mixer.	Remove debris between Bob-Tach and Concrete Mixer.
Loader will not start with Concrete Mixer removed.	Connector not installed on remote attachment control harness on the loader lift arm.	Install connector on wire harness.
Loader will not start with loader key switch with Attachment installed.	Engine stop switch on Remote Attachment Control engaged.	Turn the engine stop switch clockwise to reset the switch.
	Key switch on Remote Attachment Control in the run position.	Turn the key switch to the OFF position.
Loader will not start with the Remote Attachment Control key switch.	Engine stop switch on Remote Attachment Control engaged.	Turn the engine stop switch clockwise to reset the switch.
	Loader key switch in the run position.	Turn the loader key switch to the OFF position.
Mixer Drum does not turn.	No hydraulic flow.	Check quick couplers connection. Check for damaged hose ends and fittings. Engage loader front auxiliary hydraulics.
	Incorrect chain adjustment.	Adjust drive chain.
	Damaged sprockets and/or drive chain.	Repair or replace sprockets and drive chain.
Mixer Drum vibrates excessively.	Concrete Mixer not correctly attached to Bob-Tach.	Check for correct mounting of the Concrete Mixer to the Bob-Tach.
	Drum rollers worn.	Replace drum rollers.
	Rear shaft bent.	Replace shaft.
	Rear shaft bearing is worn or damaged.	Replace rear shaft bearing.



Bobcat®

LUBRICATION

Always use a good quality lithium base grease when lubricating the Concrete Mixer. Apply the lubricant until extra grease shows.

IMPORTANT

Fluid such as engine oil, hydraulic fluid, coolants, etc. must be disposed of in an environmentally safe manner. Some regulations require that certain spills and leaks on the ground must be cleaned in a specific manner. See local, state and federal regulations for the correct disposal.

I-2067-0395

Lubricate the following grease fittings. **EVERY 8-10 HOURS:**



Figure 10-20-1

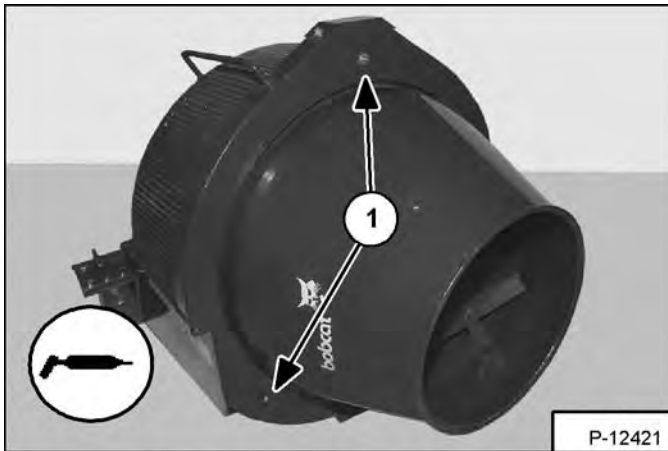
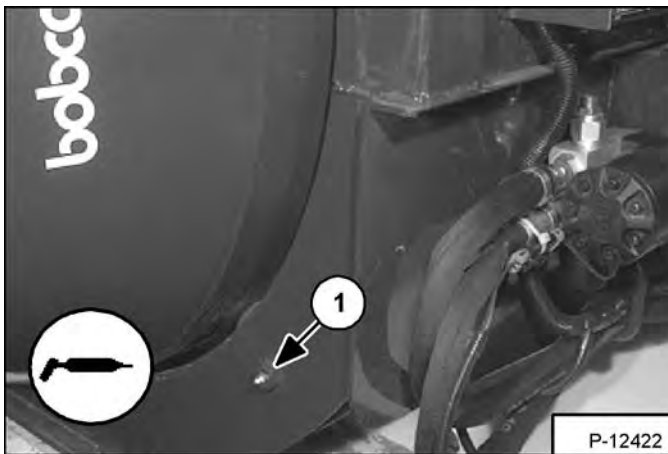

Figure 10-20-2



Drum wheels (3) (Item 1) [Figure 10-20-1] & [Figure 10-20-2].

Lubricate the following grease fitting.

EVERY 50 HOURS:



Figure 10-20-3

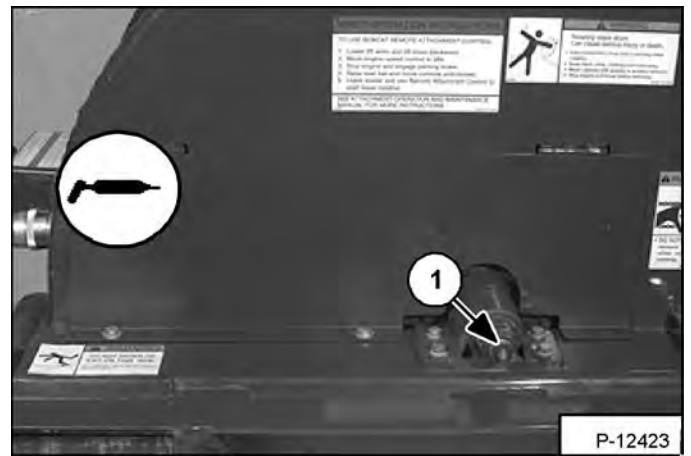

Rear drum spindle (Item 1) [Figure 10-20-3].



Bobcat®

INSPECTION

Hand Lever Bob-Tach Inspection



Bob-Tach wedges must extend through the holes in attachment. Lever(s) must be fully down and locked. Failure to secure wedges can allow attachment to come off and cause injury or death.

W-2102-0497

Figure 10-30-1

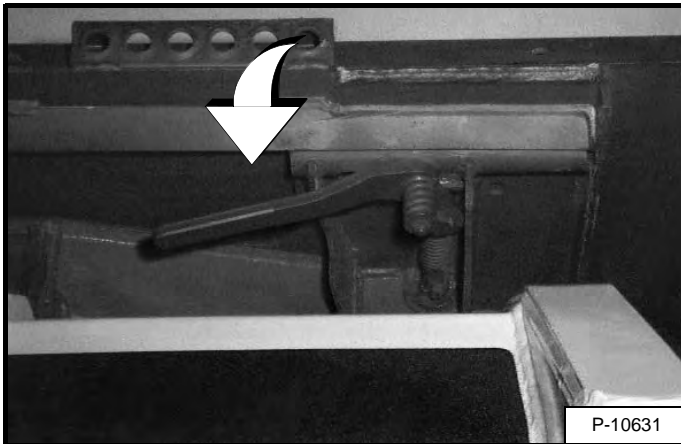

Move the Bob-Tach levers down to engage the wedges [Figure 10-30-1].

The levers and wedges must move freely.

Figure 10-30-2

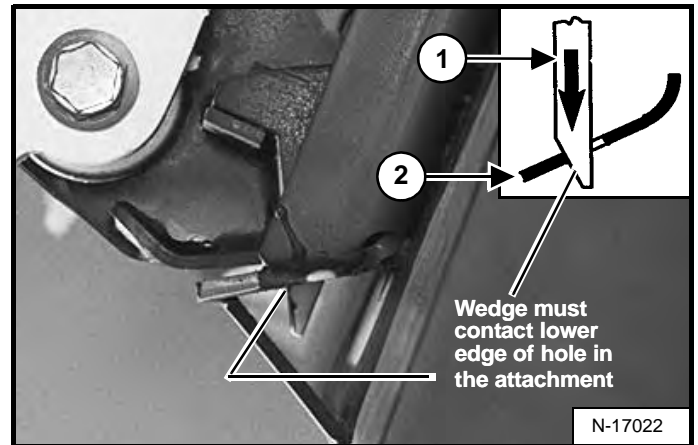

The wedges must extend through the holes in the attachment mounting frame (Item 2) [Figure 10-30-2].

The spring loaded wedge (Item 1) must contact the lower edge of the hole in the attachment (Item 2) [Figure 10-30-2].

If the wedge does not contact the lower edge of the hole the attachment will be loose and can come off the Bob-Tach.

Figure 10-30-3

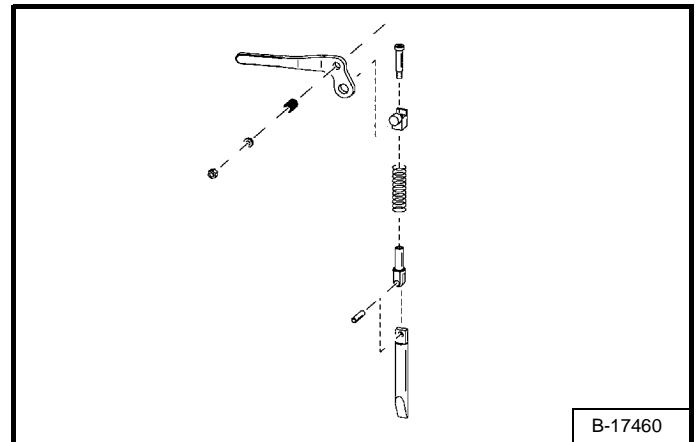

Inspect the mounting frame on the attachment and the Bob-Tach, linkages and wedges for excessive wear or damage [Figure 10-30-3].

Replace any parts that are damaged, bent, or missing.

Keep all fasteners tight.

Look for cracked welds. Contact your Bobcat dealer for repair or replacement parts.

Lubricate the wedges. (See the correct Loader Operation & Maintenance Manual for *LUBRICATION OF THE BOBCAT MACHINE*.)

INSPECTION (CONT'D)

Power Bob-Tach Inspection

! WARNING

Bob-Tach wedges must extend through the holes in attachment. Lever(s) must be fully down and locked. Failure to secure wedges can allow attachment to come off and cause injury or death.

W-2102-0497

Figure 10-30-4

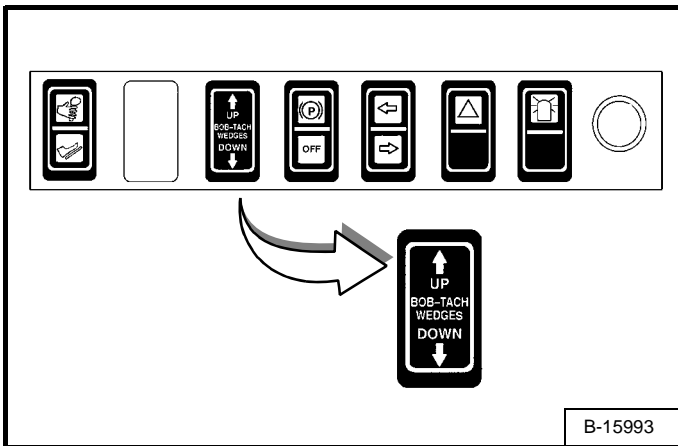

Push and hold the *BOB-TACH WEDGES UP* switch until wedges are fully raised. Push and hold the *BOB-TACH WEDGES DOWN* switch until the wedges are fully down [Figure 10-30-4].

The wedges must move freely.

NOTE: The Power Bob-Tach system has continuous pressurized oil to keep the wedges in the engaged position and prevent attachment disengagement. Because the wedges can slowly lower, the operator may need to reactivate the switch (*WEDGES UP*) before installing an attachment to be sure both wedges are fully raised before installing the attachment.

Figure 10-30-5

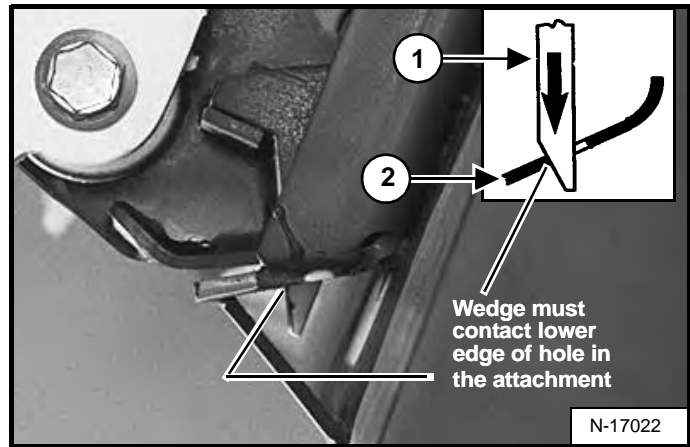

The wedges must extend through the holes in the attachment mounting frame (Item 2) [Figure 10-30-5].

The spring loaded wedge (Item 1) must contact the lower edge of the hole in the attachment (Item 2) [Figure 10-30-5].

If the wedge does not contact the lower edge of the hole the attachment will be loose and can come off the Bob-Tach [Figure 10-30-5].

Figure 10-30-6

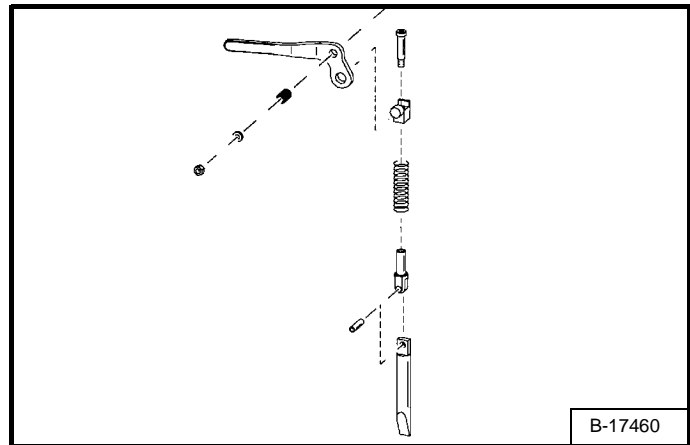

Inspect the mounting frame on the attachment and the Bob-Tach, linkages and wedges for excessive wear or damage [Figure 10-30-6].

Replace any parts that are damaged, bent, or missing. Keep all fasteners tight.

Inspect the hoses and fittings for leaks.

Look for cracked welds. Contact your Bobcat dealer for repair or replacement parts.

Lubricate the wedges. (See the correct loader Operation & Maintenance Manual for *LUBRICATION OF THE BOBCAT LOADER*.)

Dear

**Thanks very much for your visiting and
patience.**

Want to get more information,

Please click here, Go back to the page.

**After your payment, you will have instant access to
your download.**

The Download Link will also be sent to your e-mail.

You will get the complete manual

Have any questions

please write to me

admin@servicemanualperfect.com