

X 231

Excavator

Service Manual

(S/N 508911999 & Below)

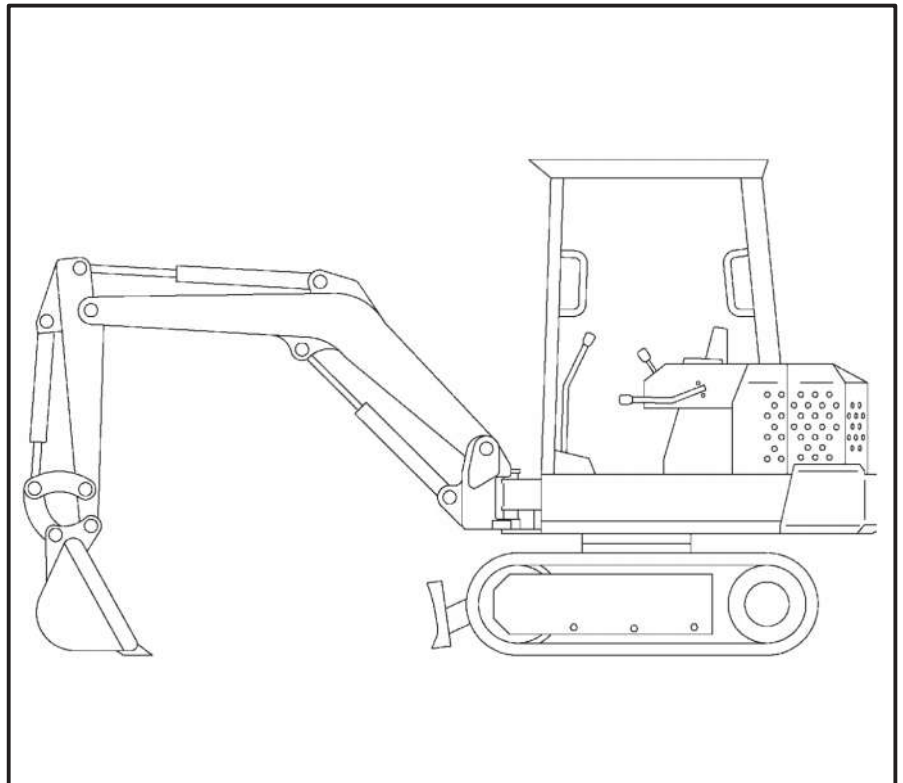

MELROE
INGERSOLL-RAND

6720496(4-90)

1 of 327

Printed in U.S.A.



© Melroe Company 1990

MAINTENANCE SAFETY



WARNING

Instructions are necessary before operating or servicing machine. Read and understand the Operation & Maintenance Manual, Operator's Handbook and signs (decals) on machine. Follow warnings and instructions in the manuals when making repairs, adjustments or servicing. Check for correct function after adjustments, repairs or service. Untrained operators and failure to follow instructions can cause injury or death.

W-2003-0903



Safety Alert Symbol: This symbol with a warning statement, means: "Warning, be alert! Your safety is involved!" Carefully read the message that follows.

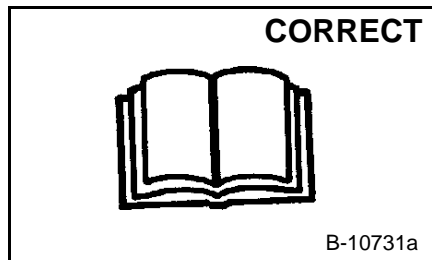

B-10731a

- ⚠ Never service the Bobcat Hydraulic Excavator without instructions.

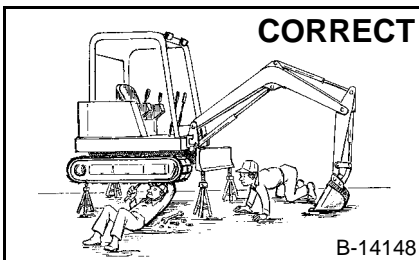

B-14148

- ⚠ Use the correct procedure to lift and support the excavator.
- ⚠ Always lift the blade fully before installing jackstands.

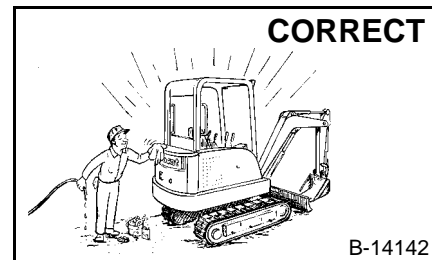

B-14142

- ⚠ Cleaning and maintenance are required daily.

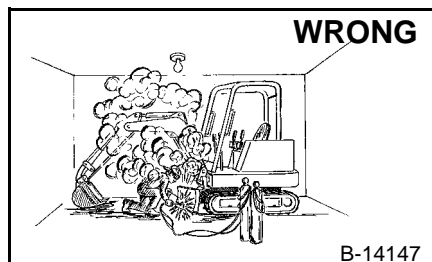

B-14147

- ⚠ Have good ventilation when welding or grinding painted parts.
- ⚠ Wear dust mask when grinding painted parts. Toxic dust and gas can be produced.

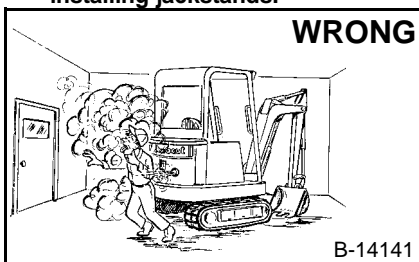

B-14141

- ⚠ Vent exhaust to outside when engine must be run for service.
- ⚠ Exhaust system must be tightly sealed. Exhaust Fumes can kill without warning.

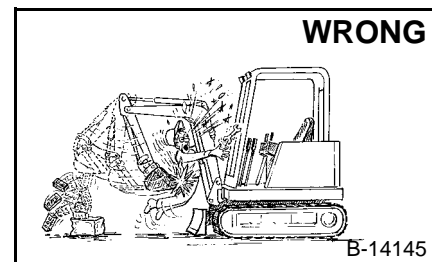

B-14145

- ⚠ Always lower the bucket and blade to the ground before doing any maintenance.
- ⚠ Never modify equipment or add attachments not approved by Bobcat Company.

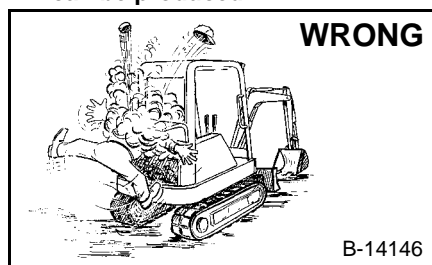

B-14146

- ⚠ Stop, cool and clean engine of flammable materials before checking fluids.
- ⚠ Never service or adjust machine with the engine running unless instructed to do so in the manual.
- ⚠ Avoid contact with leaking hydraulic fluid or diesel fuel under pressure. It can penetrate the skin or eyes.
- ⚠ Never fill fuel tank with engine running, while smoking or when near open flame.

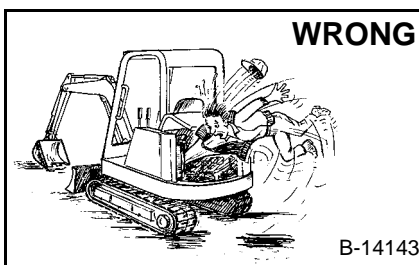

B-14143

- ⚠ Keep body, jewelry and clothing away from moving parts, electrical contact, hot parts and exhaust.
- ⚠ Wear eye protection to guard from battery acid, compressed springs, fluids under pressure and flying debris when engines are running or tools are used. Use eye protection approved for type of welding.
- ⚠ Keep rear door closed except for service. Close and latch door before operating the excavator.



B-6589

- ⚠ Lead-acid batteries produce flammable and explosive gases.
- ⚠ Keep arcs, sparks, flames and lighted tobacco away from batteries.
- ⚠ Batteries contain acid which burns eyes or skin on contact. Wear protective clothing. If acid contacts body, flush well with water. For eye contact flush well and get immediate medical attention.

Maintenance procedures which are given in the Operation & Maintenance Manual can be performed by the owner/operator without any specific technical training. Maintenance procedures which are **not** in the Operation & Maintenance Manual must be performed **ONLY BY QUALIFIED BOBCAT SERVICE PERSONNEL**. Always use genuine Bobcat replacement parts. The Service Safety Training Course is available from your Bobcat dealer.



Bobcat®

CONTENTS

SAFETY INSTRUCTIONS	v
SERIAL NUMBER LOCATIONS	vi
DELIVERY REPORT	vi
HYDRAULIC EXCAVATOR IDENTIFICATION	vii
PREVENTIVE MAINTENANCE	1-1
HYDRAULIC SYSTEM	2-1
DRIVE SYSTEM	3-1
UPPER WORKS & SWING SECTION	4-1
MAIN FRAME & TRACKS	5-1
ELECTRICAL SYSTEM	6-1
ENGINE SERVICE	7-1
TECHNICAL DATA	8-1

**PREVENTIVE
MAINTENANCE**

**HYDRAULIC
SYSTEM**

**DRIVE
SECTION**

**UPPER WORKS
& SWING
SECTION**

**MAIN FRAME
& TRACKS**

**ELECTRICAL
SYSTEM**

**ENGINE
SERVICE**

**TECHNICAL
DATA**



FOREWORD

This manual is for the Bobcat hydraulic excavator mechanic. It provides necessary servicing and adjustment procedures for the hydraulic excavator and its component parts and systems. Refer to the Operation & Maintenance Manual for operating instructions, starting procedure, daily checks, etc.

A general inspection of the following items must be made after the hydraulic excavator has had service or repair:

1. Check that the ROPS/FOPS (Including sidescreens) is in good condition and is not modified.

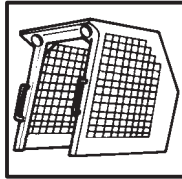

2. Check that ROPS mounting hardware is tightened and is Melroe approved.

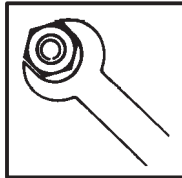

3. The seat belt must be correctly installed, functional and in good condition.

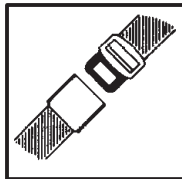

4. Inspect for loose or broken parts or connections.

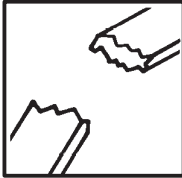

5. Machine signs must be legible and in the correct location.

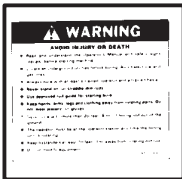

6. Steering levers, control levers and foot pedals must return to neutral. Check that foot pedals lock and control lever locks are in working condition.

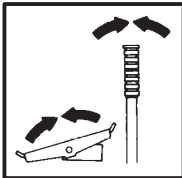

7. Inspect the air cleaner for damage or leaks. Check the condition of the element.

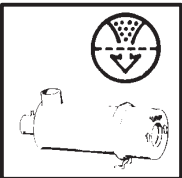

8. Check the electrical charging system.

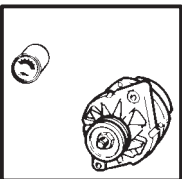

9. Safety treads must in good condition.

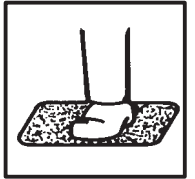

10. Check for correct function of indicator lamps (Optional on some models).

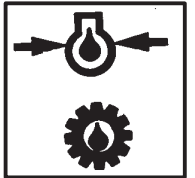

11. Check hydraulic fluid level, engine oil level and fuel supply.

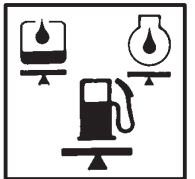

12. Inspect for fuel, oil or hydraulic fluid leaks.



13. Lubricate the loader.



14. Check the condition of the battery and cables.

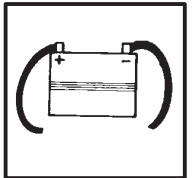

Recommend to the owner that all necessary corrections be made before the machine is returned to service.

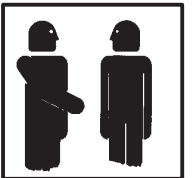



SAFETY INSTRUCTIONS

WARNING

Instructions are necessary before operating or servicing machine. Read Operation & Maintenance Manual, Handbook and signs (decals) on machine. Follow warnings and instructions in the manuals when making repairs, adjustments or servicing. Check for correct function after adjustments, repairs or service. Failure to follow instructions can cause injury or death.

W-2003-0797

The following publications provide information on the safe use and maintenance of the loader and attachments:

- The Delivery Report is used to assure that complete instructions have been given to the new owner and that the machine is in safe operating condition.
- The Operation & Maintenance Manual delivered with the loader gives operating information as well as routine maintenance and service procedures. It is a part of the loader and must stay with the machine when it is sold. Replacement Operation & Maintenance Manuals can be ordered from your Bobcat Excavator dealer.
- The excavator has machine signs (decals) which instruct on the safe operation and care. The signs and their locations are shown in the Operation & Maintenance Manual. Replacement signs are available from your Bobcat Excavator dealer.
- The CIMA Safety Manual delivered with the excavator gives information for safe operating and standard signals.
- The Service Manual and Parts Manual are available from your dealer for use by mechanics to do shop-type service and repair work.

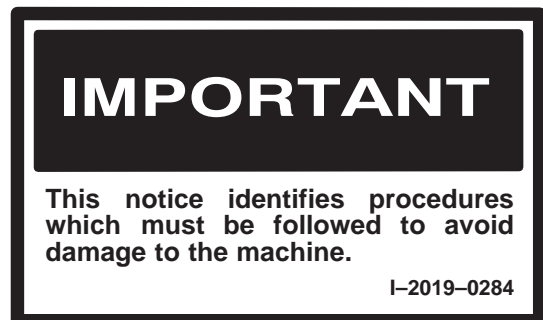

Safety Alert Symbol: This Safety Symbol is used for important safety messages. When you see this symbol follow the safety message to avoid personal injury or death.

SAFETY INSTRUCTIONS (Cont'd)

- Wear tight fitting clothing. Always wear safety glasses when maintaining or servicing the excavator. Safety glasses, hearing protection or excavator special application kits are required for some work. See your dealer for Melroe Safety equipment.
- Know where fire extinguishers and first aid kits are located and how to use them.
- Do not use the Bobcat excavator where exhaust, arcs, sparks or hot components can contact flammable material, explosive dust or gases.
- The engine compartment and engine cooling system must be inspected every day and cleaned if necessary to prevent a fire hazard and overheating.
- Check all electrical wiring and connections for damage. Keep the battery terminals clean and tight. Repair or replace any damaged part.
- Check fuel and hydraulic tubes, hoses and fittings for damage and leakage. Never use open flame or bare skin to check for leaks. Tighten or replace any parts that show leakage. Always clean fluid spills. Do not use gasoline or diesel fuel for cleaning parts. Use commercial nonflammable solvents.
- Follow any environmental safety regulations when disposing of used fluids such as engine oil, grease or anti-freeze.
- Do not use ether or starting fluids on an engine that has glow plugs. These starting aids can cause an explosion and injure you or bystanders.
- Always clean the excavator and disconnect the battery before doing any welding. Cover rubber hoses, battery and all other flammable parts. Keep a fire extinguisher near the excavator when welding. Have good ventilation when grinding or welding painted parts. Wear a dust mask when grinding painted parts. Toxic dust or gas can be produced.
- Stop the engine and let it cool before adding fuel. No smoking!
- Use the procedure in the Operation & Maintenance or Service Manuals for connecting the battery.

SERIAL NUMBER LOCATIONS

Always use the serial number of the machine when requesting service information or when ordering parts. Early or later models (identification made by serial number) may use different parts, or it may be necessary to use a different procedure in doing a specific service operation.

HYDRAULIC EXCAVATOR SERIAL NUMBER

The excavator serial number is on the machine frame, to the left of the boom [A].



ENGINE SERIAL NUMBER

The engine serial number is located on the top surface of the fuel injection pump on the engine block [B].

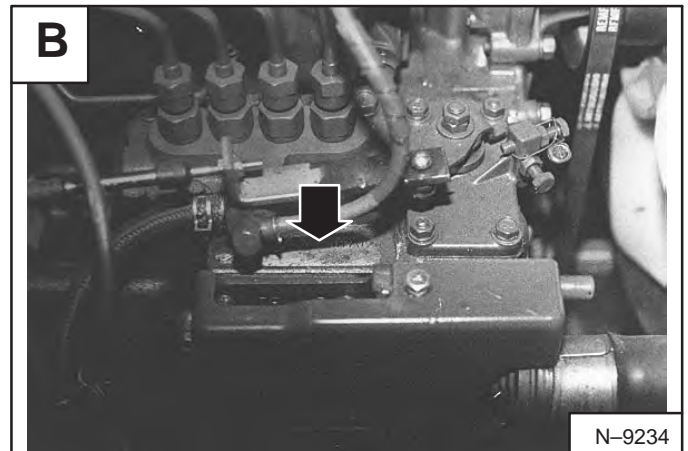

DELIVERY REPORT

The Delivery Report must be explained to the owner/operator by the dealer. The dealer is to fill out the form and the owner/operator sign the form to indicate his understanding [C].

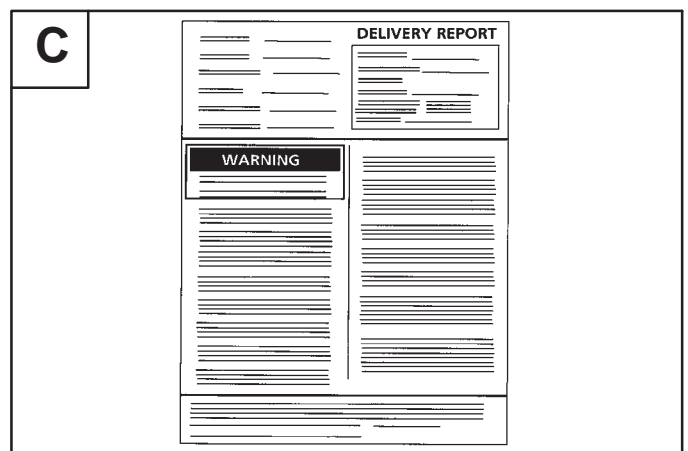

HYDRAULIC EXCAVATOR IDENTIFICATION

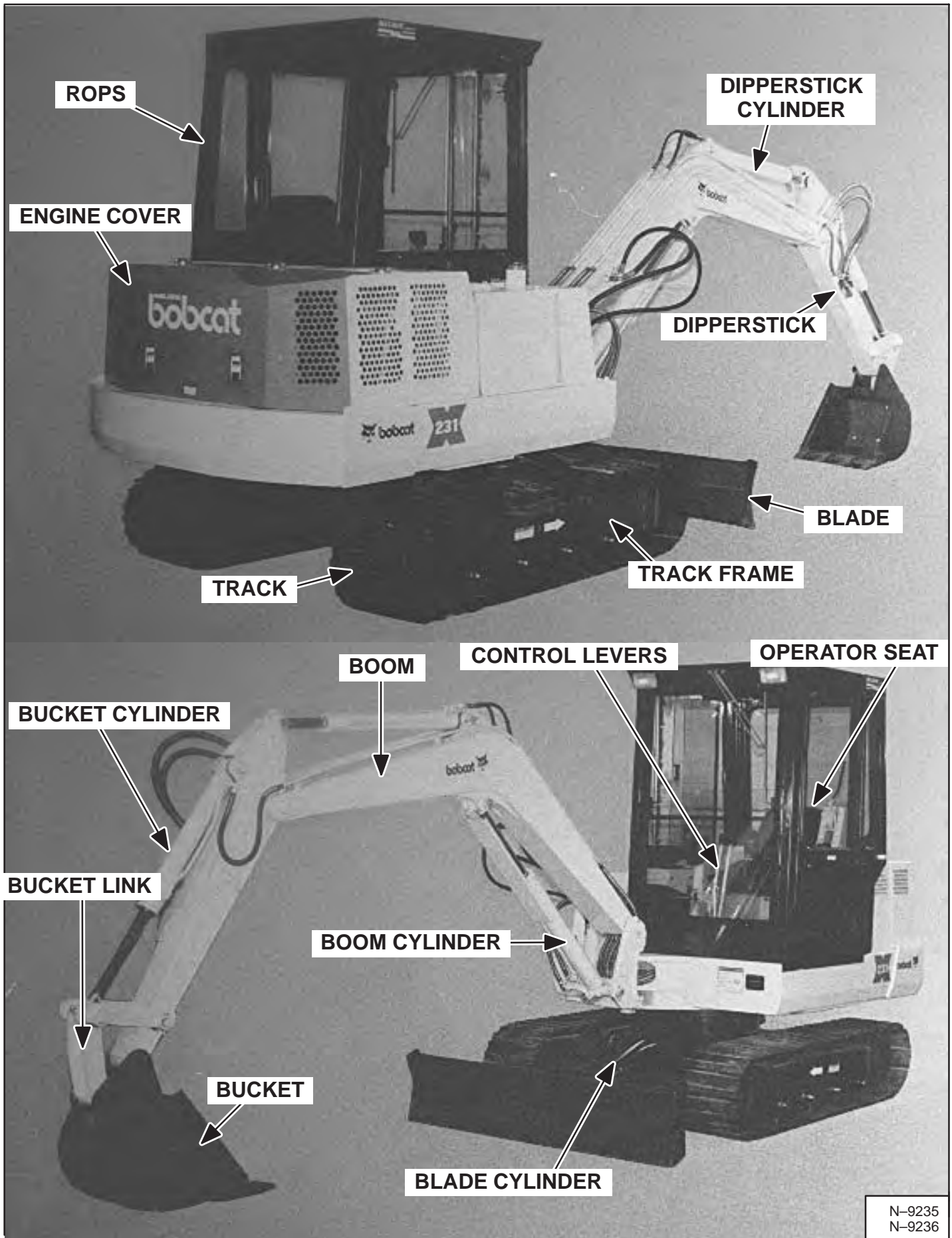

PREVENTIVE MAINTENANCE

PREVENTIVE MAINTENANCE

	Page Number
AIR CLEANER	
Servicing the Air Cleaner	1-4
COOLING SYSTEM	
Coolant Level	1-7
Coolant Replacement	1-7
ENGINE COVER	
Opening the Cover	1-4
ENGINE LUBRICATION SYSTEM	
Checking Engine Oil	1-6
Replacing Oil and Filter	1-6
FINAL DRIVE CASE	
Checking Oil Level	1-13
Draining Final Drive Case	1-13
FUEL SYSTEM	
Fuel Specifications	1-5
Fuel System Service	1-5
HYDRAULIC SYSTEM	
Checking and Adding Fluid	1-8
Hydraulic Reservoir	1-9
Replacing the Hydraulic Filter	1-8
LUBRICATION OF THE EXCAVATOR	
Procedure	1-11
SERVICE SCHEDULE	
Chart	1-3
USING A BOOSTER BATTERY (JUMP STARTING)	
Procedure	1-10



SERVICE SCHEDULE

Maintenance work must be done at regular intervals. Failure to do so will result in excessive wear and early failures. The service schedule is a guide for correct maintenance of the Hydraulic Excavator.



WARNING

Instructions are necessary before operating or servicing machine. Read Operation & Maintenance Manual, Handbook and signs (decals) on machine. Follow warnings and instructions in the manuals when making repairs, adjustments or servicing. Check for correct function after adjustments, repairs or service. Failure to follow instructions can cause injury or death.

W-2003-0797

SERVICE SCHEDULE		HOURS					
ITEM	SERVICE REQUIRED	8-10	50	100	250	500	1000
Engine Air Cleaner	Check & empty dust cap as required.						
Engine Oil	Check the oil level & add oil as needed.						
Engine Coolant System	Check coolant level in recovery tank.						
Indicator Lights	Check for correct operation.						
Operator Cab	Check the fastening bolts, nuts, & condition of cab.						
Seat Belt	Check the condition & that fasteners are tight.						
Safety Signs (Decals)	Check for damaged signs (decals) replace as needed.						
Control Locks	Check for correct function.						
Tracks	Check and adjust tension.						
Hydraulic Reservoir	Check fluid level.						
All Machinery Pivot Pts.	Lubricate 20 grease fittings.						
Fuel Tank	Drain water & sediment from fuel tank.						
Swing Circle	Lubricate two grease fittings.						
Swing Pinion	Lubricate one grease fitting.						
Engine Oil & Filter	Replace oil & filter element.						
Alternator Belt	Check & adjust tension.						
Final Drive Case	Check fluid level & add oil as needed.						
Hydraulic Filter	Replace filter element.						
Fuel Filter	Replace filter element.						
Battery	Check & clean cable ends & check electrolyte level.						
Air Cleaner	Replace the filter element.						
Cooling System	Clean the radiator fins.						
Alternator & Starter	Check the condition.						
Engine Valve Clearance	Check & adjust valve clearance.						
Swing Motor Gear Red.	Check oil level.						
Cooling System	Drain, flush & add new coolant to the cooling system.						
Hydraulic Tank	Change the fluid, clean fill neck strainer & suction strainer. Replace hydraulic filter.						
Final Drive Case	Change the oil.						

After the first 50 hours of machine operation do the following:

- * Replace the hydraulic fluid filter.
- * Check the condition of fan belt.

After the first 250 hours of machine operation do the following procedures:

- * Change oil in final drive case.
- Or Every 12 Months.

Dear

**Thanks very much for your visiting and
patience.**

Want to get more information,

Please click here, Go back to the page.

**After your payment, you will have instant access to
your download.**

The Download Link will also be sent to your e-mail.

You will get the complete manual

Have any questions

please write to me

admin@servicemanualperfect.com